

House Security
Guarder

SECURE YOUR HOME

INSTALLATION AND USER MANUAL

Wireless Smart Security System



GSM- SMS- APP
Wireless Smart Security System

Dear users

Thank you for having selected the intelligent alarm system. Please read through this manual before installation so as to operate properly.

The intelligent alarm system adopts the newest GSM network and Digital Signal Processing technology. And it is widely used in security fields, such as it can protect your home, store, office, factory etc. It really realizes wireless alarm dealing and controlling remotely, conveniently and flexible, and solves the limitation of wired data transmission in telephone and wired network.

Perfect structure, convenient installation, easy operation with wireless remote controllers are designed for the idea of people-oriented, which will make you feel easy and comfortable while using this intelligent alarm system.

“People is center, technology is first” is our company's action rule. Customer satisfaction is our consistent pursuit. Perfect system, excellent services, sincere attitudes will bring you a new enjoyment.

Contents

1. Content of Package	1
2. Alarm System Installation Position	2
3. GSM SMS Alarm Control Panel	3
3.1 Main functions	3
3.2 Specification	4
3.3 Control Panel: Front	4
3.4 Control Panel: Back	5
3.5 Control Panel: side	6
4. Installation and operation	7
4.1 Installing the SIM card	7
4.2 Running	7
5. Programming by SMS Command	8
5.1 Programming 3 mobile phone numbers for receiving	8
5.2 Programming 3 phone numbers for receiving voice calling alarm	9
5.3 Deleting alarm phone numbers	9
5.4 Modifying password of alarm host	10
5.5 Arm/Disarm	10
5.6 Modifying zone's name	10
5.7 Modifying the installation address name	11
5.8 Inquiring arm/disarm status	12
5.9 Inquiring AC power status of alarm host	12
5.10 6 different Languages for optional	12
5.11 Setup independent zone	12
5.12 Cancel independent arm	13
5.13 Setup delay alarm time	13
6. Programming by phone keypad remotely	14
7. Operation steps	15
7.1 Arm/disarmed by remote controller	15
7.2 External AC power failure alarm	15
7.3 Handling Alarm	16
8. The connection method for wired detectors and speaker	17
9. How to add additional sensors?	18
9.1 Adding additional PIR movement sensors	18
9.2 Adding additional wireless door sensor?	21
9.3 Adding additional remote controllers to work with alarm panel?	22
10. Operation Cautions	23
11. Guarantee Card	24
12. Encode method	25
13. SMS Command	26

1. Content of Package



Control Panel complete with GSM dialer, backup battery and 110-240V AC/12VDC power adapter

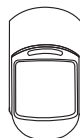

PIR motion sensor complete with battery

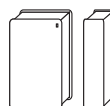

Magnetic door and window contact complete with battery

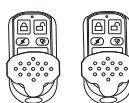

Remote controllers complete with batteries



Wired siren with volume 110DB

Tips: there're 8 different packing kits, each kit comes with different sensors/accessories.

2. Alarm System Installation Position

In order to ensure an efficient and secure protection of the installation place (home or office) all weak points need to be carefully identified. Every sensor identifies an individual zone and is recognized sequentially during the programming.

The names of the 10 sensors can be personalized

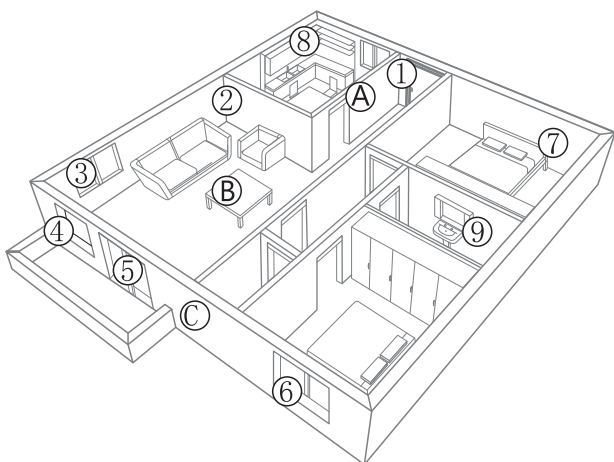

- Ⓐ Control panel
- Ⓑ Remote controllers
- Ⓒ Siren

- ① Zone 01 sensor
- ② Zone 02 sensor
- ③ Zone 03 sensor
- ④ Zone 04 sensor
- ⑤ Zone 05 sensor
- ⑥ Zone 06 sensor
- ⑦ Zone 07 sensor
- ⑧ Zone 08 sensor
- ⑨ Zone 09 sensor
- ⑩ Zone 10 sensor

3. GSM SMS Alarm Control Panel



The device is such an alarm system with GSM dialer that provides the following protection functions: Enable to operate by smart phone iOS or Android App;

Arm or disarm by remote control; SMS message indicate Built-in 6 languages: English, Russian, German, French, Spanish, Chinese;

3.1 Main functions

- 3 SMS message alarm numbers.
- 3 voice call alarm numbers.
- Enable 6 languages voice prompt.
- 10s voice record.
- Enable two-way communications.
- 24 Hours emergency alarm zone, and fire alarm zone.
- Backup battery enable up to 10 hours standby.
- 12 wireless zones and 2 wired zones.
- Enable to setup Independent zone.

3.2 Specification

1. Wireless frequency: 433MHz/315MHz;
2. GSM frequency: 900/1800/850/1900MHz (quad band)
3. Alarm response time: 8s (GSM signal in normal)
4. Power requirements: AC100V ~AC 240V, 50Hz/60Hz
Working consumption: <0.6W
Backup battery: DC7.4V/800mAh
Backup battery working hours: 10 hours
5. Working condition:
Temperature: -20°C ~+60°C
Humidity: 95% (non-condensation)
6. Size: 150mm(L)×100mm(W)×16mm(H)
7. Record time: 10s

3.3 Control Panel: Front

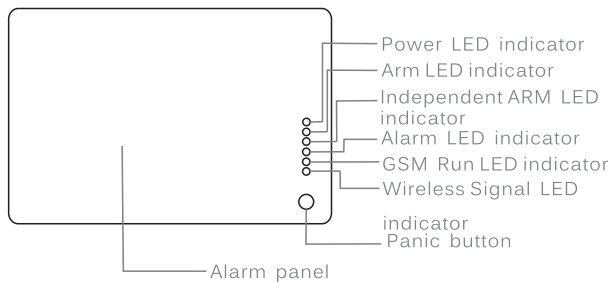

1. Panic button: press it when any emergency happen
2. Wireless LED indicator: blink when receiving wireless signal from remote control, door sensor, etc.
3. GSM signal LED indicator: blinking every 2s GSM signal in normal status.
4. ALARM LED indicator: the indicator is on when alarming or the system get into setting status.
5. Independent arm LED indicator: the LED is on when the sensors of independent zone in arm mode.
6. ARM LED indicator: when the alarm host in arm mode, the LED indicator is on, it's off when it's disarmed.
7. Power LED indicator: External AC power is connected well, the LED is on; external AC power is failure, the LED is off.

3.4 Control Panel: Back

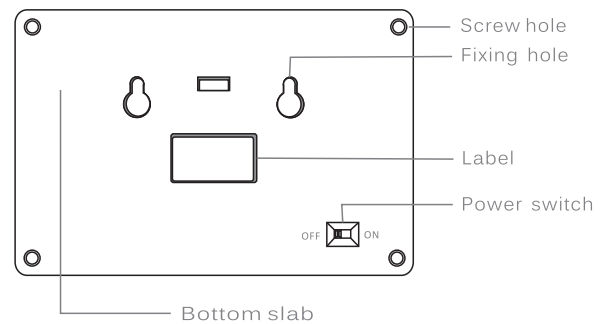

Fixing hole: fixing the alarm host;

Power switch: Switch to right is on, switch to left is off.

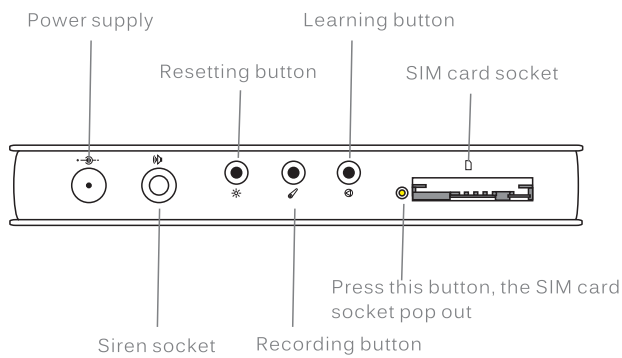

3.5 Control Panel: side

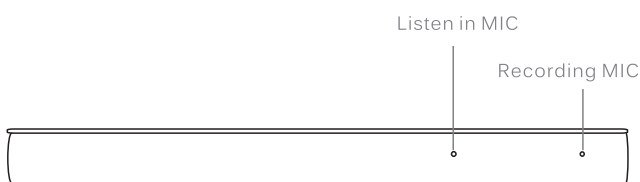

4. Installation and operation

4.1 Installing the SIM card

The alarm host transmits alarm information by GSM SMS & voice platform, so you should prepare a SIM card before the installation. (If you use a new SIM card, make sure the new SIM card can send SMS and make calls normally.)

Notes: Please turn off the power before inserting SIM card and make sure the direction is correct.

4.2 Running

Make sure the power supply well connected, and then switch on the power, the ALARM, ARM, and POWER LED indicators will be on, the RUN LED indicator will blink. Then the host will get into initialization and GSM network searching mode, about 25s later, there's two "di di" beep sounds that means the host will enter into normally working status. At this moment, the ALARM/ARM LED indicator will be off, the RUN LED indicator will keep blinking every 2s/time.

Notes: If GSM Run indicator keeps blinking 1s/time, that means GSM signal in abnormal status.

5 Programming by SMS Command

5.1 Programming 3 mobile phone numbers for receiving alarm text message

Send SMS: 4 digits password + DD + serial number + mobile phone number.

Example: The initial password is 1234; programming mobile phone number 13888888888 as the first SMS alarm phone number.

Send SMS to alarm host: 1234DD113888888888

Send:

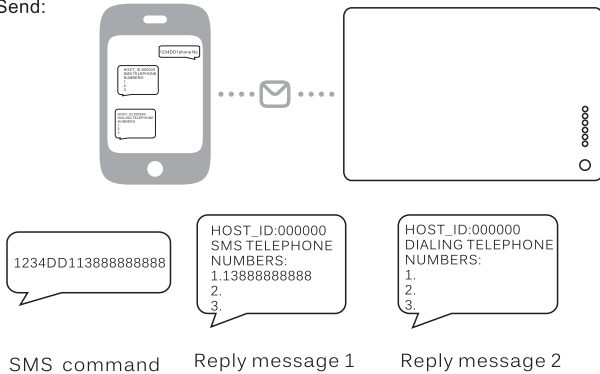

Alarm host will reply with 2 SETTING messages to first SMS alarm number for confirming.

Note: DD is a fixed command, the alarm text message sequence is 1,2,3.

Fixed command form, as following:

DD1	First SMS alarm No.
DD2	Second SMS alarm No.
DD3	Third SMS alarm No.
DD4	First voice dialing No.
DD5	Second voice calling No.
DD6	Third voice calling No.

5.2 Programming 3 phone numbers for receiving voice calling alarm

Send SMS: password + DD + serial number + phone/mobile phone numbers.

Example: The host's initial password is 1234; programming 13888888888 as the first voice calling alarm phone number. Send SMS to alarm host: 1234DD413888888888

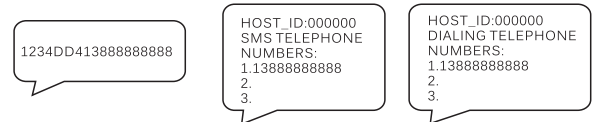

Alarm host will reply with 2 SETTING messages to first SMS alarm number for confirming.

Note: DD is a fixed command, the alarm voice call sequence is 4,5,,6.

5.3 Deleting alarm phone numbers

Send SMS: Password + DD + serial number.

Example: The host's password is 1234.If you want to delete the first alarm phone number, please

Send SMS: 1234DD1

Note: The serial number shows alarm sequence (must be 1, 2, 3, 4, 5, 6).

5.4 Modifying password of alarm host

Send test message:

1234DD75678

1234 is the initial password,DD7 is the fixed command, 5678 is the new password.

After setting successfully, the new password will be sent to the first SMS alarm phone number.

5.5 Arm/Disarm

Arm by SMS: 4 digits password + A1.

Disarm by SMS: 4 digits password + A2.

Example: The host's password is 1234. If you want to program the host in arm mode by remotely control, then Send SMS: 1234A1.

5.6 Modifying zone's name

Send SMS: 4 digits password + DM + zone's No. (2 digits) + New zone's name.

Reply SMS: New zone's name.

Example: The host's password is 1234. If you want to the modify the name of zone 01 into "my bedroom PIR Alarm".

1234DM01 my bedroom PIR Alarm

Zone's No. as following:

Zone 01	Zone 06
Zone 02	Zone 07
Zone 03	Zone 08
Zone 04	Zone 09
Zone 05	Zone 10

Send SMS: 1234DM01my bedroom PIR Alarm.

Note: The new name should be less than 24 characters.

Zone's code in 2 digits: 01 to 11, of which, zone 11 is the emergency zone, and zone12 is default as fire alarm zone.

Both of the zones are unable to modify zone's name.

5.7 Modifying the installation address name

Send SMS: "4 digits password"+ "DM00"+ "user defined name".

After modifying successfully, alarm host will send the new installation name to first SMS alarm numbers by text message.

1234DM00 Room 1,5F

5.8 Inquiring arm/disarm status

Send SMS: 4 digits password + W1

Reply SMS: The host's arm/disarm status

5.9 Inquiring AC power status of alarm host

Input SMS: Password + W2

Reply SMS: host's AC power status

5.10 6 different Languages for optional

Send SMS:

"Password" + "LG" + "series number1/2/3/4/5/6"

Notes: The series number stands for following language.

1 stands for Chinese

2 stands for English

3 stands for Russian

4 stands for Spanish

5 stands for German

6 stands for French

After setting successfully, alarm host will send a text message to first SMS alarm number for confirming.

5.11 Setup independent zone

User can setup part of the zones to independent zone.

Independent zone is only enable to disarm through SMS command, which is to prevent the special places. Firstly, programming alarm zone as the independent zone, Send SMS: "4 digits password" + "AA" + "zone series number"

Notes: "zone's number" stands for 10 zones (from zone 01 to zone10), it is allowed to program multi-zones as independent zones.

Example: If you want to program zone 01, 03, 04 as independent zones, send SMS: 1234AA01, 03, 04.

Notes: Between each zone, you must use a comma ",", for separating.

SMS reply: the status of each zone, of which "A" stands for the zone has been in status of independent zone.

5.12 Cancel independent arm

Send SMS to cancel independent zone, send SMS: "password" + "AD" + "Zone series number"

Example:

If you want to cancel independent zone 01,03, 04,

then send SMS to alarm host:

1234AD01,03,04

Please use a comma ",", to separate each zone.

5.13 Setup delay alarm time

Send SMS: Password + DY + digits(0,1,2,3,4)

Note: The digit 0 means 0 seconds, 1 means 15 seconds, 2 means 30 seconds, 3 means 45 seconds, 4 means 60 seconds.

Example: you want to setup delay alarm time 30s, then please send SMS to alarm host and the text message is 1234DY2.

6. Programming by phone keypad remotely

User can use any telephone or mobile phone to dial the phone number in the host, the host will automatically get through after 15 seconds detecting and remind you of inputting password (initial password is 1234) with voice prompt. After input correct password, you can start site listen in and you can "input command" through phone keypad, as following:

- 1) Pressing "1" to arm,
- 2) Pressing "2" to disarm,
- 3) Pressing "3" to activate siren,
- 4) Pressing "4" to deactivate siren working.
- 5) Pressing "*", alarm host will beep with 2 "di, di" sounds, and then automatically enter into setting status. You can delete pre-set alarm phone numbers as following:
 - 1) Pressing "1#" to delete first alarm SMS NO.
 - 2) Pressing "2#" to delete second alarm SMS No.
 - 3) Pressing "3#" to delete third alarm SMS NO.
 - 4) Pressing "4#" to delete first voice call No.
 - 5) Pressing "5#" to delete second voice call No.
 - 6) Pressing "6#" to delete third voice call No.

Note: Every time when you press the button on the phone keyboard, the host will make beep sounds for response. If not, it means your operation is unsuccessful, please re-operate it.

7. Operation steps

7.1 Arm/disarmed by remote controller

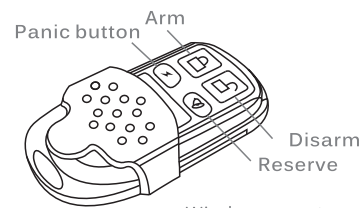

"🔒": press Arm button, alarm host will reply with a "di" sound to confirm receive wireless signal.

After 30s, alarm host will auto get into arm mode.

"🔓": press the DISARM button, alarm host will reply with two "di di" sounds to confirm and auto get into disarm mode.

"⚡" press the PANIC button, alarm host will alert at once no matter in arm or disarm mode.

Press "🔒" and then press "⚡" within 30s, the alarm will get into quick arm mode.

7.2 External AC power failure alarm

When an emergency alarm occurs, press the button "⚡" or the panic button on the alarm host, then the alarm host will get into emergency alarm mode immediately, then it will automatically start the siren

for 90 seconds to inform the neighbors. At the same time, the system will automatically send the SMS of "Emergency alarm" and dial the pre-set phone numbers cycled for three times.

7.3 Handling Alarm

When an alarm occurs, the system will start siren for 90 seconds to inform the neighbors. At the same time, the system will automatically send SMS and dial the pre-set phone numbers. When any phone is answered, the system will playback the pre-recorded voice and listen in at site. At this moment, the user presses the phone keypad:

- "1"-----arm
- "2"-----disarm
- "3"-----start the siren
- "4"-----switch off siren

If the phone line is busy or can't get through, the system will auto-dial the next phone number circularly till one of them is answered. If nobody answers the phone, the system will stop dialing after auto-dialing circularly for three times.

Note: When you are listening in, the host is still on the arm mode. If any detectors are triggered again, the host will broadcast the zone numbers to you.

8. The connection method for wired detectors and speaker

The alarm host is configured with 2 wired alarm zones and two-way communication functions.

The wiring method is as following:

Open the host's case with a screwdriver, there're 6 wires inside the host. Shown as below:

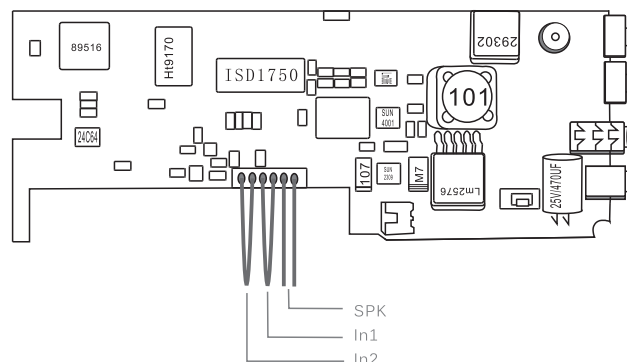

Red wire: the anode of the speaker;
 Black wire: the cathode of the speaker.
 The two yellow wires are for wired zone 1;
 The two green wires are for wired zone 2.

Connection sample:

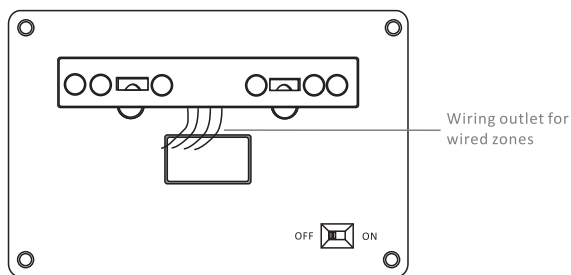

9. How to add additional sensors?

9.1 Adding additional PIR movement sensors

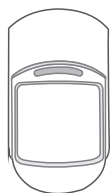

Wireless PIR movement sensor

Tips: Each wireless zone can work with no limited wireless sensors (set the sensors in the same zone)

Firstly, please open the wireless PIR movement sensor, you will see the internal structure of the PIR sensor, same as below picture shown:

Internal chart

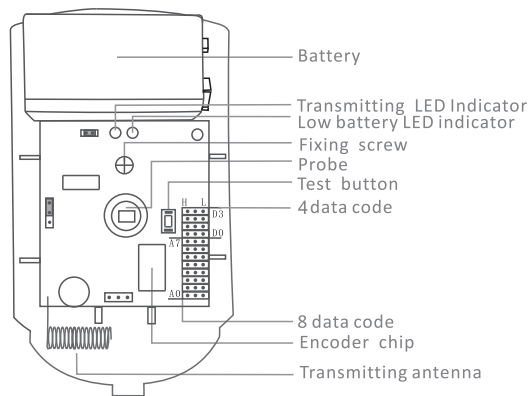

You will see some pins, which is from A7 to A0, and from D3 to D0. A7 to A0 is address code, which should correspond with alarm host's wireless address. D3 to D0 is data code for setting defence zone.

Which position you need to put jumpers so that it can correspond with alarm host's code & defence zone's code ?

We should know the regulation that which position means 0, which position means 1, which position means 2. There are three columns pins, L N H, when you put a jumper to L column and N column, it stands for 0. When you put a jumpers to N column and H column, it stands for 1. If you did not put any jumpers, it stands for 2.

The wireless address code can be saw on page 25.

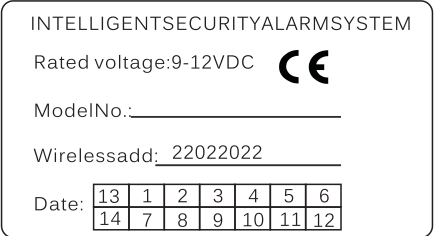

For example, the wireless address code is 22022022, and make the wireless PIR sensor to zone 1.

- 1) Check the wireless address code on the back side of the alarm host (different alarm host has different wireless address.) Wireless address: 22022022 (from A7 to A0)
- 2) Check the zone's code in the last page of operation manual: Zone1 from D3 to D0: 0101
- 3) Please using jumpers to connect the pins. From A7 to A0 and then from D3 to D0

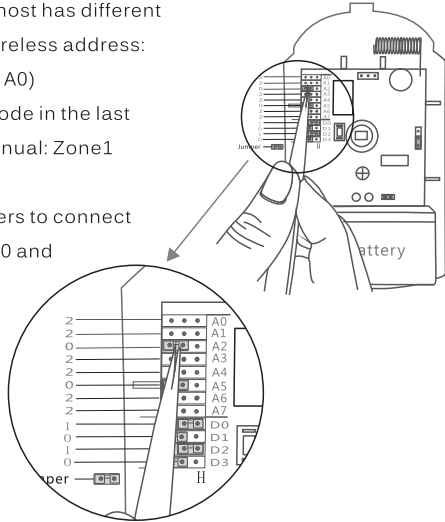
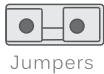

After finishing setting, please test the new adding PIR motion sensors.

Kindly tips:

By using the same method, add additional door sensor, smoke sensor, glass breaking sensors etc.

9.2 Adding additional wireless door sensor.

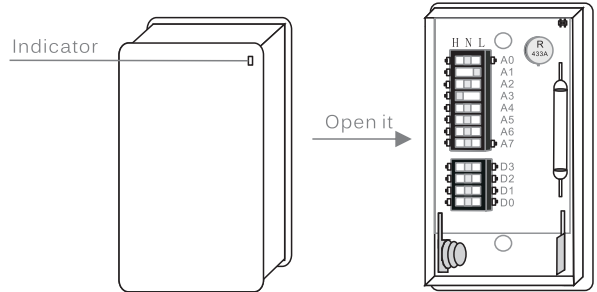

Open part A of the door sensor

Put the switch from A7 to A0 for wireless address code and defense zone code from D3 to D0. Notes: from the table (item 12), we know the 0110 is zone 2.

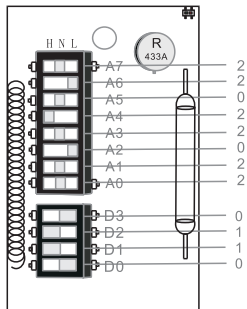

Tips:
if your door sensor with jumper pins, the adding method same as PIR motion sensors.

9.3 Adding additional remote controllers to work with alarm panel

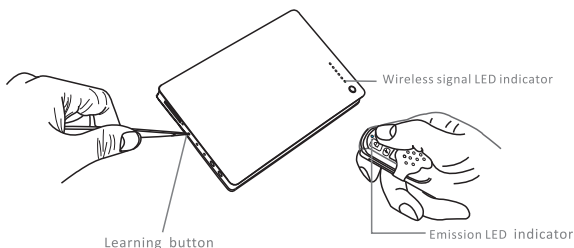

Please short press the learning button, the wireless signal LED indicator will be on, and then long pressing any one button on the remote controllers for 3s, when wireless signal LED indicator goes out, it means adding successfully. At this moment, please press ARM/DISARM button for double-test. Every press on the remote controllers, the wireless signal LED indicator will blink once as well as the alarm host will make beep sounds "di, di" to confirm that it receives the command from remote controllers.

10. Operation Cautions

1. Make sure the equipments have no water.
2. Install the system in a hidden place, but with normal GSM network.
3. Turn off the power supply before insert/take out the SIM card.
4. Have a hard connection to the main power supply and provide good heat dissipation.
5. The alarm host will get into normal running status about 25's later.
6. Check all the detectors and their batteries in time and change them when power is low.
7. Please don't install the PIR motion sensors face to the window directly for avoiding sunshine.
8. Don't install the system close to the objects which generate strong interference, such as TV set and computer.
9. Inspect the GSM alarm system timely.
10. This product is designed for the indoor use rather than outdoor use.
11. Inspect the SIM card in the alarm host (GSM signal is ok, and the balance of SIM card, etc)

11. Guarantee Card

Customer			
Product Model		Product ID NO.	
Production Date		Purchase Date	
Maintenance records			

12. Encode method

Name	Wireless address code from A0 to A7 (1~8)	D0 (10)	D1 (11)	D2 (12)	D3 (13)
Alarm host	Series number from right to left A0-A7	NC	NC	NC	NC
Remote control		NC	NC	NC	NC
Wireless sensors	Zone 01	1	0	1	0
	Zone 02	0	1	1	0
	Zone 03	1	1	1	0
	Zone 04	1	0	0	1
	Zone 05	0	1	0	1
	Zone 06	1	1	0	1
	Zone 07	0	0	1	1
	Zone 08	1	0	1	1
	Zone 09	0	1	1	1
	Zone 10	1	1	1	1
	Panic button		0	0	1
Fire zone		1	1	0	0

INTELLIGENT SECURITY ALARM SYSTEM
 Rated voltage: 9-12VDC

Model No. _____

Wireless add: 22022212

Date:

13	1	2	3	4	5	6
14	7	8	9	10	11	12

A7 A6 A5 A4 A3 A2 A1 A0

Remark:
 A0-A7 & D0-D3 use jumper pins or tin soldering for connecting the pins to match wireless address code.
 Connect N&H stands for "1", connect N&L stands for "0".
 No connection stands for "2".

13. SMS Command

Command	Sample	Result
[Password]DD1Cell phone No.	1234DD113888888888	Set the first SMS alarm No.
[Password]DD4 phone No.	1234DD413888888888	Set the first calling alarm No.
[Password]DDseries number	1234DD1	Delete the first SMS alarm No.
[Password]DD7new password	1234DD75678	Modify password
[Password]W1	1234W1	Check arm/disarm status
[Password]W2	1234W2	Check AC power status
[Password]A1	1234A1	Arm
[Password]A2	1234A2	Disarm
[Password]DM zone No. new zone name	1234DM06 bedroom PIR	Zone 06 has been modified as bedroom PIR
[Password]DM00new installation address name	1234DM00 No.11building	The new installation address is No.11 building
[Password]AAzone number	1234AA01,02,03	Zone 01,02,03 independent arm
[Password]ADzone number	1234AD01	Cancel zone 01 independent arm
[Password]LG series number	1234LG3	Switch to Russian language
[Password]DY[0/1/2/3/4]	1234DY4	Delay alarm 60s